

DSQD

4 Channel Digital Receiver DSQD, DSQD/AES3

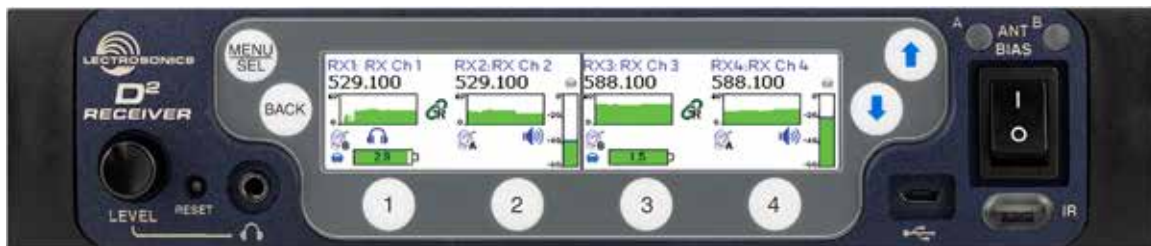

Fill in for your records:

Serial Number:

Purchase Date:



Table of Contents

- Introduction** 2
- General Technical Description** 2
 - Encryption 2
 - Digital Hybrid Wireless® Technology..... 3
 - LCD Screen 3
 - Diversity Reception..... 3
 - Infrared Sync..... 3
 - What is Dante?..... 3
- Panels and Features**..... 4
 - DSQD Front Panel..... 4
 - DSQD Rear Panel..... 4
 - IR (infrared) Port..... 5
 - USB Port 5
 - Headphone Volume Adjustment..... 5
 - Channel Selector Buttons 5
 - Dante Ports (if Dante module is installed) 5
 - Ethernet Port..... 5
 - Multi-Frame Communication..... 5
 - Power Inlet 5
- LCD Menu Map**..... 6
- Navigating the Menus** 8
- RF Setup Menu** 8
 - RF Frequency..... 8
 - Frequency Scan 8
 - Tuning Groups..... 9
 - Tuning Group Setup 9
 - Diversity Setup..... 10
- Audio Setup Menu** 12
 - Audio Level 12
 - Audio Polarity..... 12
 - Smart Noise Reduction 12
 - Compatibility Modes..... 12
 - Talkback Setup 12
- IR Sync & Encryption Menu**..... 13
 - Encryption Key Management..... 13
 - Encryption Keys..... 13
 - Sync Settings 13
 - Tools and Settings Menu..... 14
 - RX On/Off..... 14
 - TX Battery Type..... 14
 - Front Panel Setup 14
 - Antenna Bias Power 14
 - Network Settings 14
 - Edit Names..... 15
 - Restore Defaults 15
 - Pilot Tone Bypass 15
 - About..... 15
 - Links 15
- Specifications and Features**..... 15
- Wireless Designer**..... 15
- Firmware Update Instructions**..... 15
- Supplied Hardware**..... 16
 - Unpacking the Unit 16
 - Items Included in the Box:..... 16
- Optional Accessories**..... 17
- Installing two DSQD Receivers into a SingleRack Space**..... 18
- M2T/DSQD Rack Mounting Instructions**..... 20
- Troubleshooting**..... 24
- Service and Repair** 25
 - Returning Units for Repair..... 25

Introduction

The latest digital radio technology is employed in the DSQD receiver to set a new standard for performance and flexibility. Four discrete audio channels are packed into a single half-rack chassis, with balanced analog and Dante® digital network outputs. The receiver tunes continuously across the UHF band from 470.100 to 614.375 MHz.

The digital architecture delivers studio quality audio with ultra-low latency. The receiver includes an extended operating range rivaling the best analog and Digital Hybrid Wireless® systems with tracking filters that stay centered on the selected frequency.

The DSQD is also backward compatible with any Digital Hybrid Wireless® transmitters including the SM Series, LT, HM Series, SSM, HH Series, UM400, UM400a, LM Series, MM Series, and WM.

The receiver provides a USB port for firmware updates, an IR port for fast setup and an ethernet port for control. A large, high resolution, backlit LCD and large membrane switches provide an intuitive interface that is highly visible in daylight or dimly lit conditions.

Wireless Designer™ software integrates the digital and Digital Hybrid Wireless® into a single control panel with site scanning and frequency coordination. The software is free and can be used while connected to equipment or offline in planning a multi-channel system.

Antenna ports on the rear panel accept input from remote antennas, with a “loop-thru” output to another mainframe using the internal multicoupler. A kit is also available to mount antenna inputs (BNC connectors) on the front panel.

General Technical Description

Encryption

When transmitting audio, there are situations where privacy is essential, such as during professional sporting events, in court rooms or private meetings. For instances where your audio transmission needs to be kept secure, without sacrificing audio quality, Lectrosonics implements AES256 encryption in our digital wireless microphone systems. High entropy encryption keys are first created by the DSQD Receiver. The key is then synced with an encryption-capable digital transmitter, via the IR port. The audio will be encrypted and can only be decoded if both DSQD and transmitter have the matching encryption key. If you are trying to transmit an audio signal and keys do not match, all that will be heard is silence.

Digital Hybrid Wireless® Technology

All wireless links suffer from channel noise to some degree, and all wireless microphone systems seek to minimize the impact of that noise on the desired signal. Conventional analog systems use companders for enhanced dynamic range, at the cost of subtle artifacts (known as “pumping” and “breathing”). Wholly digital systems defeat the noise by sending the audio information in digital form.

To support the installed base of Digital Hybrid Wireless systems, the DSQD receiver includes DSP algorithms for compatibility with Digital Hybrid Transmitters.

The DSQD receiver uses a DSP generated ultrasonic pilot tone to reliably mute the audio when no RF carrier is present. The pilot tone must be present in conjunction with a usable RF signal before the audio output will be enabled. 256 pilot tone frequencies are used across each 25.6 MHz block within the tuning range of the system. This alleviates erroneous squelch activity in multichannel systems where a pilot tone signal can appear in the wrong receiver via IM (intermodulation).

LCD Screen

Easy navigation of all setup parameters is provided by a full color, backlit LCD screen and membrane push buttons. The high resolution display provides comprehensive monitoring of all receiver parameters.

Diversity Reception

Three different receiver diversity schemes can be employed depending on the needs of the application, including antenna switching (during packet headers for seamless audio), Digital Vector Diversity or Digital Frequency Diversity.

NOTE: Ratio Diversity instead of Vector Diversity is available in earlier models, which is explained on page 10.

Infrared Sync

The DSQD has a bi-directional IrDA interface which allows quick syncing of settings and encryption keys to transmitters (including legacy transmitters) with the push of a button. The receiver also offers tuning groups to allow the user to set up a list of frequencies, allowing for easy tracking of frequency tuning in the transmitters.

What is Dante?

Audinate's patent pending Dante™ technology is a flexible Internet Protocol (IP) and Ethernet based digital AV network technology that eliminates the many bulky cables needed to provide point-to-point wiring for analog AV installations.

With Dante, existing infrastructure can be used for high performance audio as well as for ordinary control, monitoring or business data traffic. Digital networks utilize standard IP over Ethernet offering high bandwidth capable of transporting hundreds of high quality channels over Gigabit Ethernet.

Set-up and configuring the system is made easy as well, saving enormous installation costs and long term cost of ownership on a digital network. The physical connecting point is irrelevant: audio signals can be made available anywhere and everywhere. Patching and routing now become logical functions configured in software, not via physical wired links.

Summary of Dante Benefits

- Plug-and-play technology – automatic discovery and simple signal routing
- Reduced Cost & Complexity- No special skills required to set up audio networking
- Sample accurate playback synchronization
- Add/remove/rearrange components at will
- Deterministic latency throughout the network
- Support mixed bit depths and mixed sample rates over one network
- Scalable, flexible network topology, supporting a large number of senders and receivers
- Supports 1Gbps networks
- Supports a single integrated network for audio, video, control, monitoring
- Uses inexpensive, off-the-shelf computer networking equipment

DSQD Front Panel

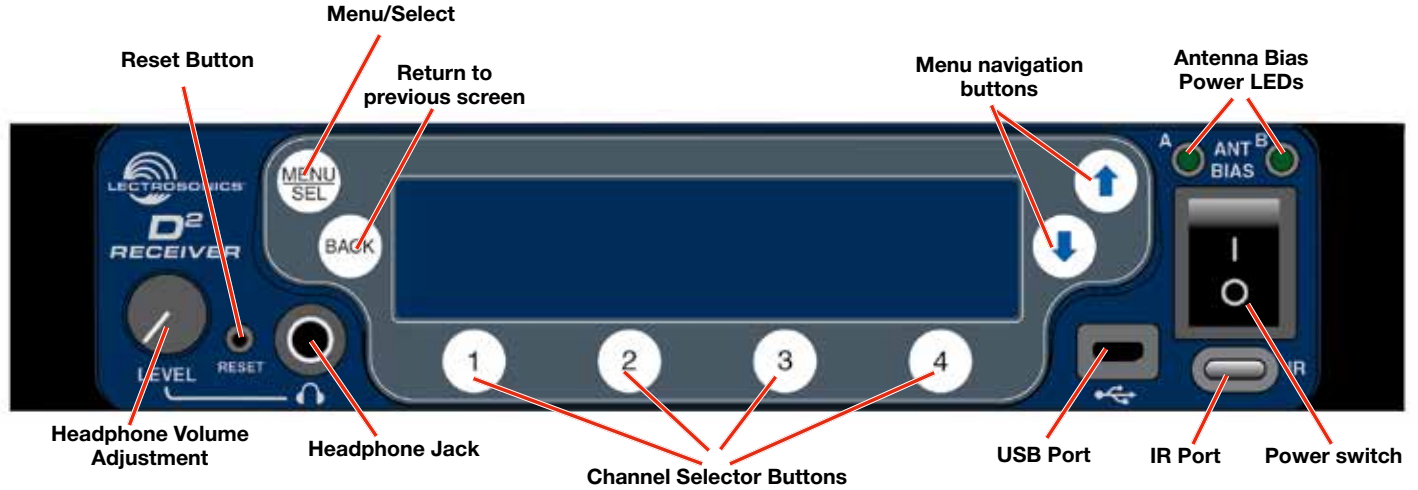

DSQD Rear Panel

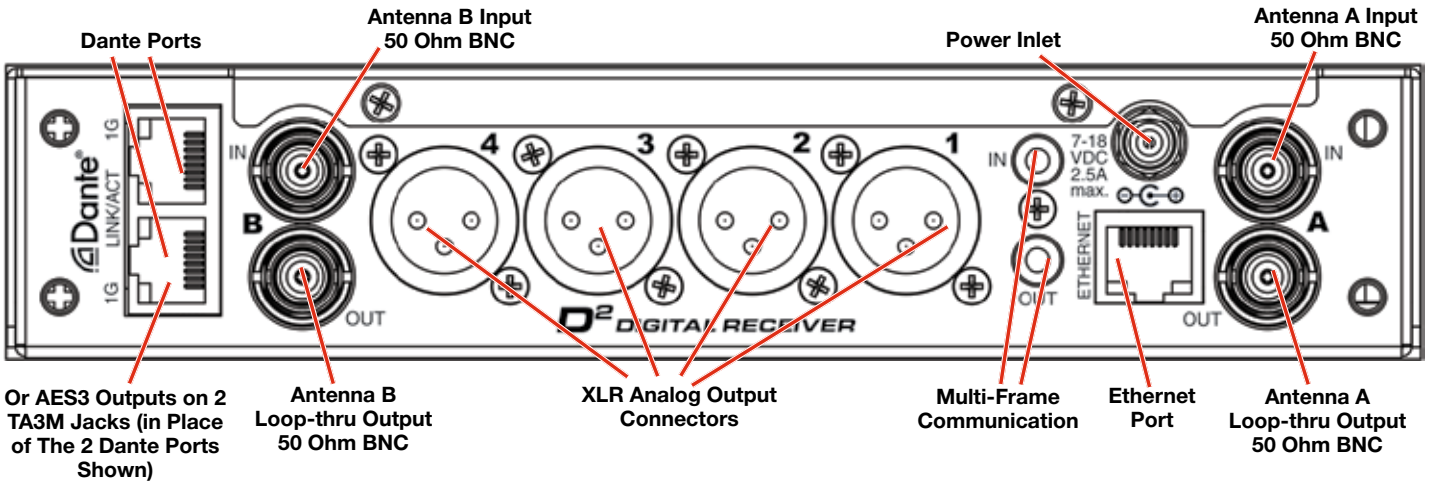

IR (infrared) Port

Frequency and settings can be transferred to and from the DSQD receiver via this port to an IR enabled transmitter to simplify setup.

USB Port

For firmware updates and connection to Wireless Designer software.

Reset Button

For MCU recovery in the event of an interrupted firmware update.

Headphone Volume Adjustment

Knob adjusts the headphone monitor.

Antenna Bias LEDs

Illuminated when antenna bias power is turned on.

Channel Selector Buttons

From the main screen, pressing a **Channel Selector Button** will show a detailed channel screen (see **Quick Start** for more information).



NOTE: Press and holding channel selector buttons will initiate a sync with a transmitter from most screens.

Antenna Loop-thru

For multiple DSQD installations in a rack, a “loop-thru” is available to feed two or three receivers from a single antenna pair. Connect coaxial cables from the multicoupler loop-thru outputs on the first receiver to the antenna inputs on the next receiver in the stack.

Tip: it is good practice to only enable antenna bias power on receivers connected directly to the antennas.

Dante Ports (if Dante module is installed)

Connects to a Dante digital audio network.

AES3 Ports (DSQD/AES3 option)

AES3 outputs on two TA3M jacks (in place of the two Dante ports shown)

Ethernet Port

Used for setup, monitoring and control with Wireless Designer software or 3rd party control systems connected via a network.

Multi-Frame Communication

Allows offline, multi-frame communication and frequency coordination.

Power Inlet

The locking DC coaxial inlet requires 7-18 VDC and draws a maximum of 2.5 A at 7 V (with all channels powered, Dante module powered, and antenna bias power on both channels).

Operating Instructions

To begin using the DSQD quickly, follow the steps below. The other settings can be adjusted as needed.

1. Set Channel Frequency: Assign a frequency to each channel, which will correlate to the accompanying **Channel Selector Button** (1-4). From the **Quick Access Menu** or the **RF Setup Menu**, manually set frequency on the **RF Frequency** screen or scan for available frequencies and assign a frequency to each channel from the **Frequency Scan** screen.

2. Set Compatibility Mode: From the **Quick Access Menu** or the **Audio Setup Menu**, set compatibility modes for each channel.

3. Set Encryption Keys: From the **IR Sync & Encryption Menu**, select a key type and then create a key (if needed).

NOTE: See **Encryption Key Management** for more instruction.

4. Sync Settings: From the **Quick Access Menu** or the **IR Sync & Encryption Menu**, initiate sync for each channel via the IR port. Hold the target transmitter close to the IR port on the front panel of the DSQD. Select **SEND ALL**. A message will appear on the main screen letting you know the sync was successful. Messages will appear letting you know if the sync was successful.

NOTE: See **Sync Settings** for more instruction.

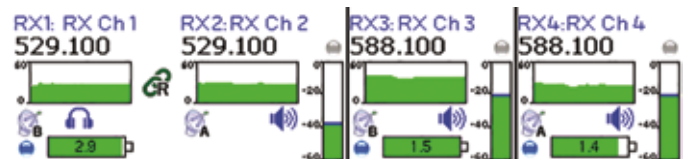

5. You can also quickly check a channel’s status by pressing a **Channel Selector Button** from the DSQD home screen. This screen allows you to change a variety of settings, including status of the compatibility mode, diversity setting, transmitter battery status, audio level and audio mute status.

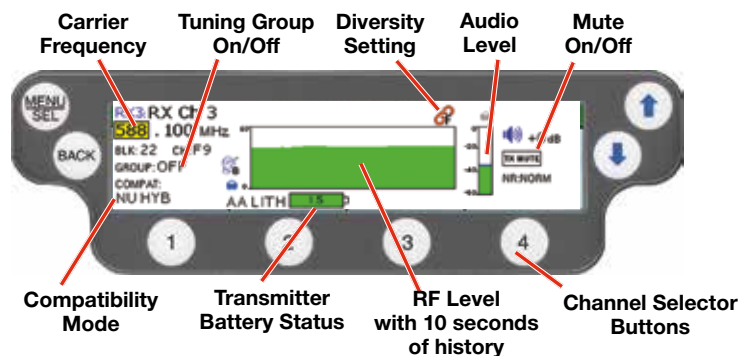

LCD Menu Map

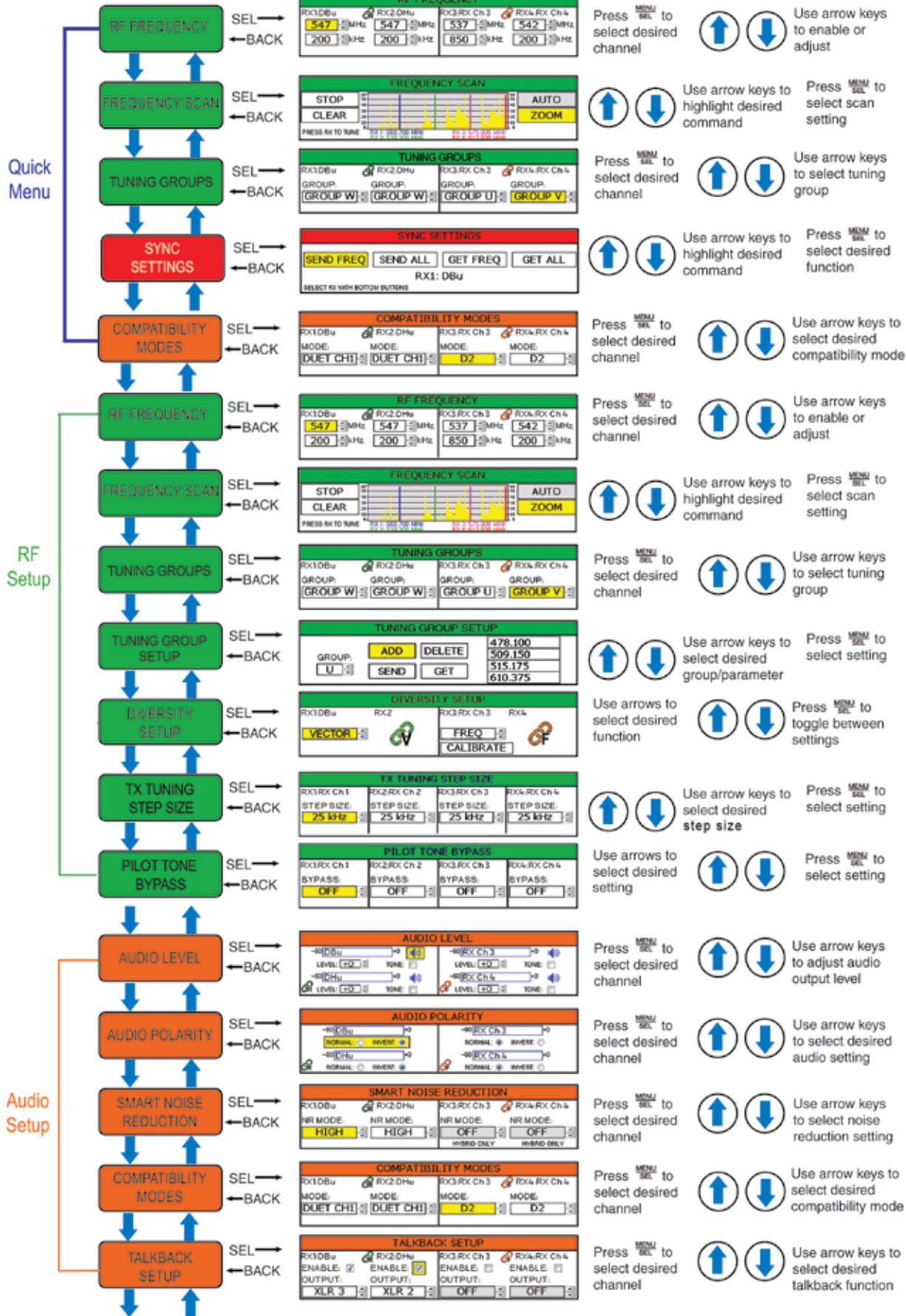

IR Sync & Encryption

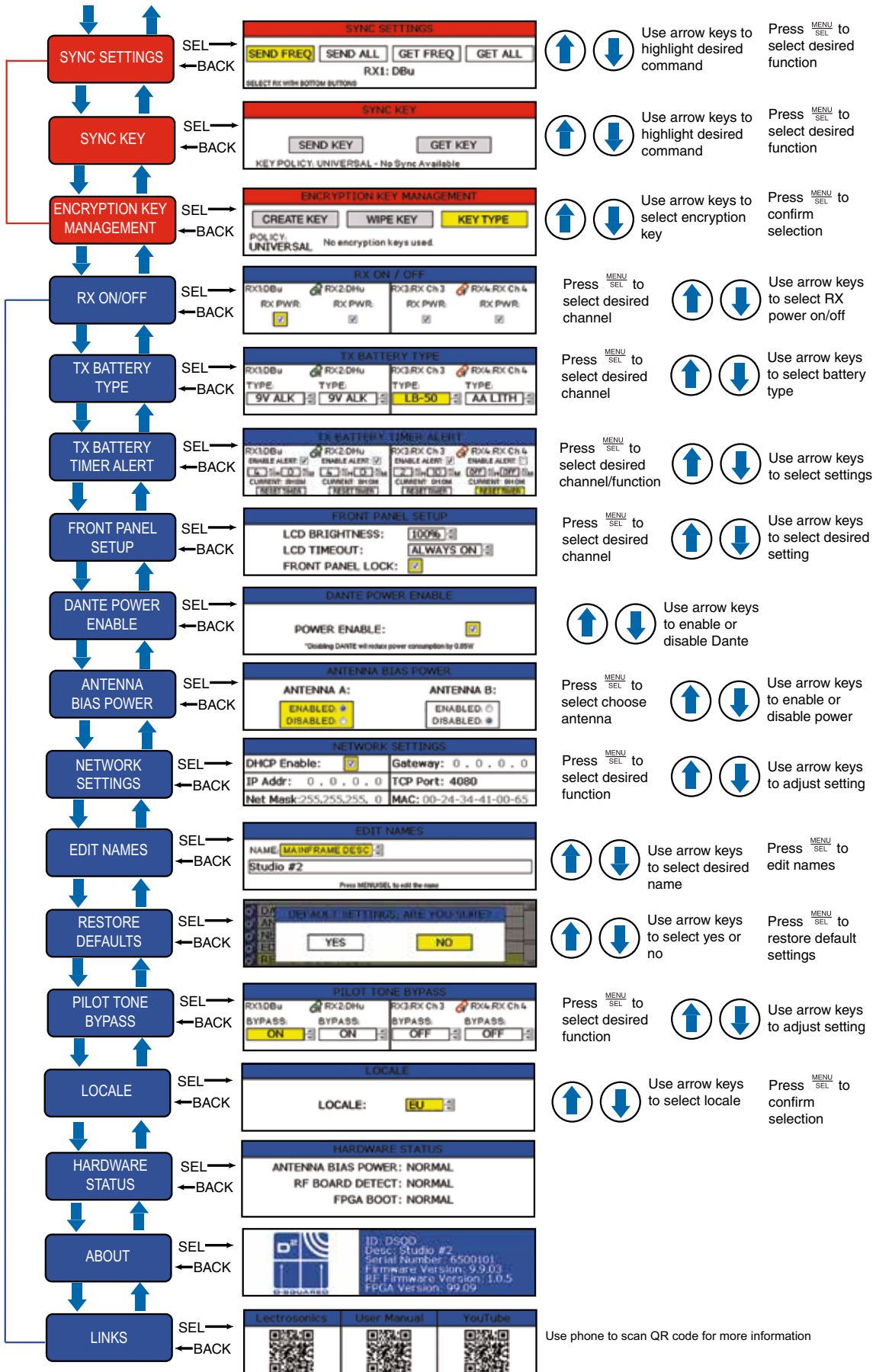

Tools & Settings

RF Level Status

RF level status (and things you may need to check) is indicated by the color that appears in the status bar.

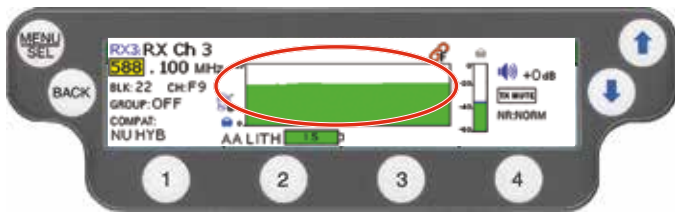

- **Green:** The receiver is successfully demodulating the signal and correctly supplying audio.
- **Yellow:** The receiver is able to see the signal but the audio is currently squelched, either because of poor signal quality or encryption issues. Pilot tone and/or digital packet headers are present.
- **Red:** The receiver sees RF energy but cannot comprehend it in the current Compatibility mode. This means no Pilot tone in Hybrid modes and no Packet Headers in digital modes. Can be caused by external interference.

Navigating the Menus

All Setup Menu items are arranged in a vertical list on the LCD. Press **MENU/SEL** to enter the menu, then navigate with the **UP** and **DOWN** arrows to highlight the desired setup item.

NOTE: To guarantee chosen parameters are saved, exit a setup screen **BEFORE** powering down DSQD.

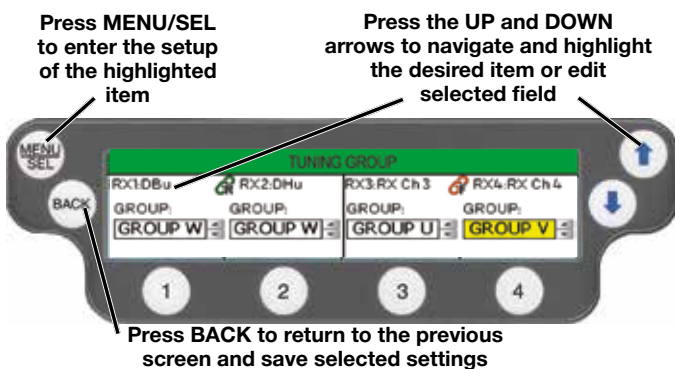
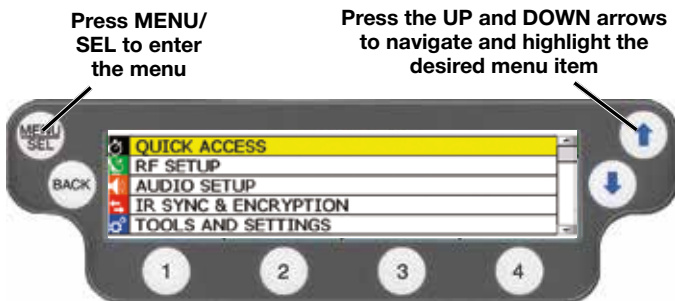

Quick Access Menu

The quick access menu is a list of menu items grouped together for DSQD quick start:

- RF Frequency
- Frequency Scan
- Tuning Groups
- Sync Settings
- Compatibility Modes

RF Setup Menu

RF Frequency

Allows manual selection of the operating frequency for each channel.

NOTE: Display varies with compatibility mode selection.

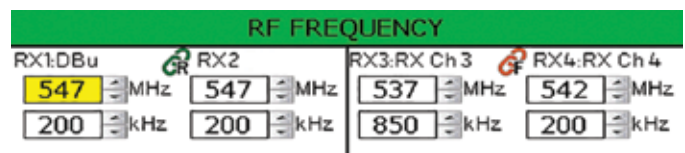

Frequency Scan

1. To begin, press **MENU/SEL** to start the scan.

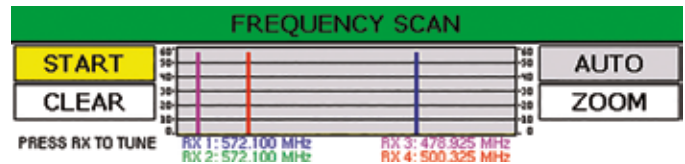

NOTE: All four channels scan at the same time. You can also select individual channels for scanning by pressing the channel selector buttons.

2. Once the scan has completed, use **UP** and **DOWN** arrows to navigate to **ZOOM**, then press **MENU/SEL**.

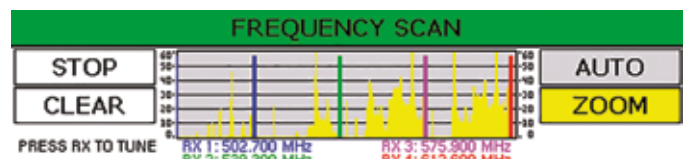

3. Press one of the four channel selector buttons. The word **TUNING** will flash on the screen to let you know you are tuning. Press the **UP** and **DOWN** arrows to tune the channel into the area of lowest RF activity.

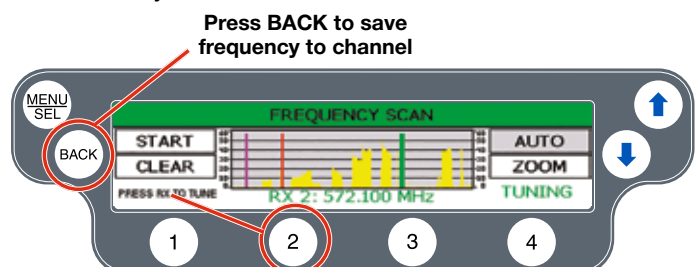

Tuning Groups

Assign a tuning group to a channel.

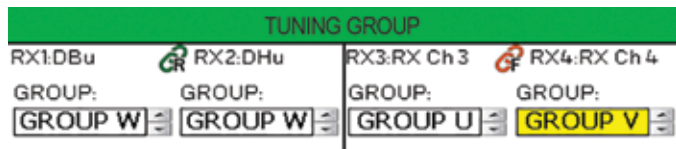

Tuning Group Setup

Tuning groups allow the user to set up a list of frequencies, allowing for easy tracking of frequency tuning in the transmitters. Use **MENU/SEL** to move through the options and **UP** arrow to make a selection.



- Four tuning groups are available: U, V, W, X.
- Each group has the option to add or delete a frequency from the list on the right. Use the **UP** and **DOWN** arrows to change frequencies, **MENU/SEL** to move through the options, and the **UP** arrow to select **ADD** or **DELETE**. Push the **BACK** button to return to the Group Tune Setup Screen.

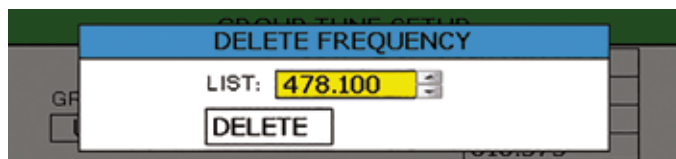
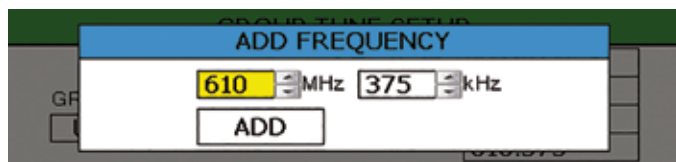

- Each group can store up to 32 frequencies.
- The user can then send or get all frequency groups.

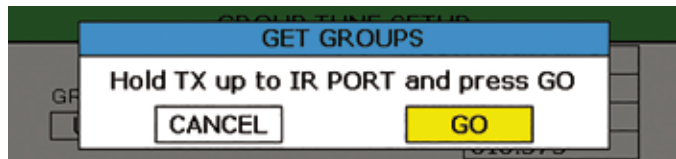

When a tuning group is assigned, the frequency control is limited to the frequencies contained in the tuning group. It also limits the available frequencies in the frequency coordination process.

Diversity Setup

Diversity is a DSQD feature that safeguards against loss of audio signal caused by RF interference. The DSQD architecture allows three different types of diversity reception. Once chosen, the diversity mode is shown on other screens with a link icon. (Visit the DSQD page on lectrosonics.com for a video with more details on Diversity.)

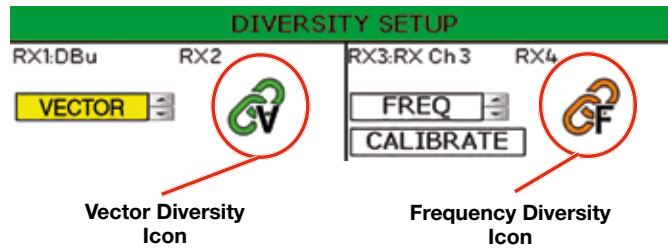

- **Switched:** Of the two antennas available on the DSQD, the receiver selects the antenna with the best signal. In this mode, there are four receivers available.

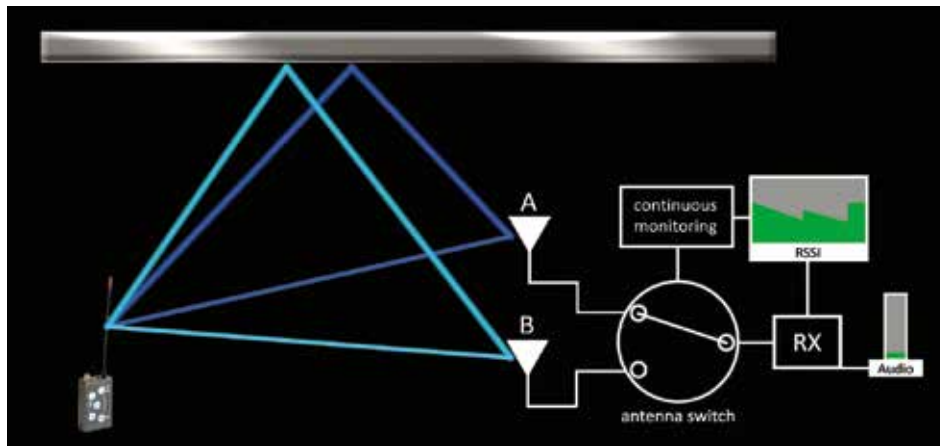

- **Vector:** In this mode, two receiver channels can be “paired” as one receiver. Either Channels 1 and 2 or channels 3 and 4 can be combined into a pair. One receiver in a pair is fixed on Antenna A and the other receiver in a pair is fixed on Antenna B. The DSQD automatically and optimally combines the intermediate frequency signals.

NOTE: Vector diversity is available in units with serial numbers higher than 6500661 in DSQD and 6500601 in DSQD/AES3. In units with earlier serial numbers, ratio diversity is available.

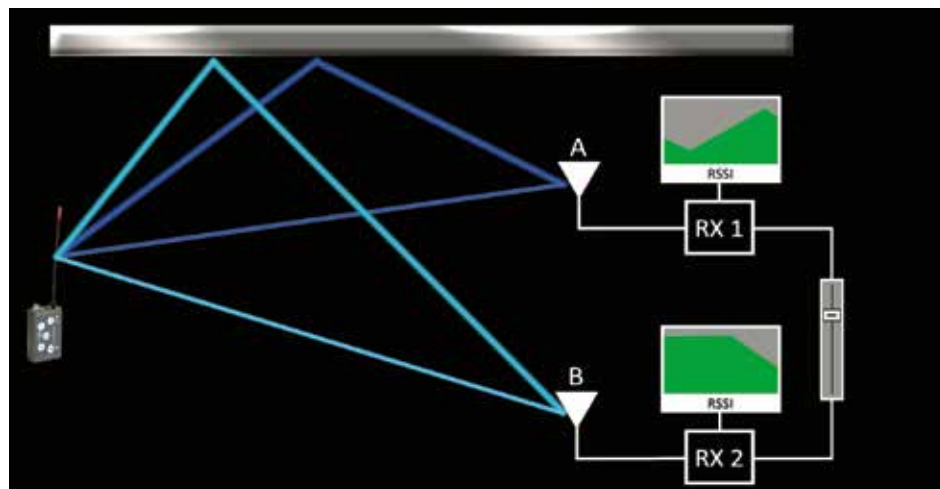

- **Frequency:** Again, the receiver channels are paired. In this mode, each channel is set to a different frequency. The DSQD automatically uses whichever receiver's RF signal quality is better. The use of separate frequencies helps minimize dropouts caused by multi-path phenomenon. This technique uses both switched and vector diversity for maximum effectiveness.

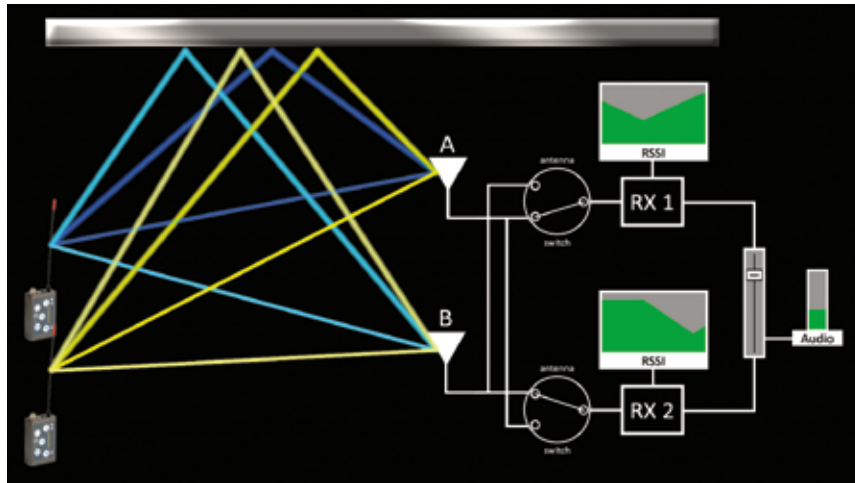

NOTE: To maximize frequency diversity, choose frequencies separated as far apart as possible.

When using Frequency Diversity, performance can be optimized by using a calibration technique to balance the audio levels between the two transmitters in the pair. Follow these steps:

1. Plug headphones into the DSQD front panel monitor jack.
2. Select **CALIBRATE** on the Diversity Setup screen.
3. The Calibrate TX Gain pop-up screen will appear.

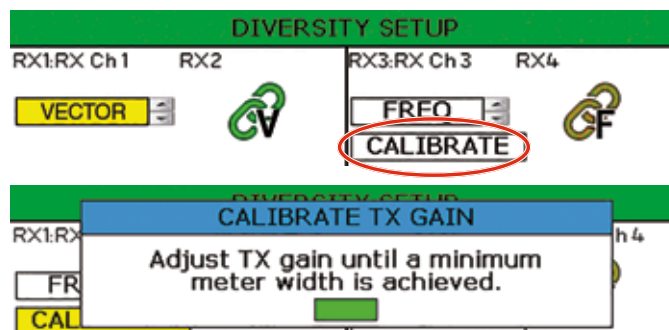

4. Adjust the microphone gain on each transmitter to balance the audio level while observing the green bar on the screen. When audio level is balanced, the green bar is minimized.

WARNING: Use caution when calibrating. Resulting headphone volume may be very loud.

WARNING: Transmitter gain should also be set in accordance with transmitter manual to achieve correct modulation.

Audio Setup Menu

Audio Level

Set audio output level with the level control. The mute button is a toggle used to mute or unmute the audio output. The **TONE** check box is used to generate a 1 kHz test tone at the audio output.



Audio Polarity

Select normal or inverted polarity for each audio channel.



Smart Noise Reduction

Three levels of noise reduction are available: High, Normal and Off.

NOTE: Smart Noise Reduction is only available for digital hybrid compatibility modes.

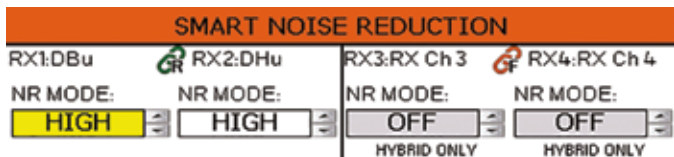

Compatibility Modes

Multiple compatibility modes are available to match various transmitter types.

The following modes are available:

- D2: Encrypted digital wireless channel
- DCHX: Two channel encrypted mode.
- DUET CH1: To receive Channel One audio from a Duet transmitter
- DUET CH2: To receive Channel Two audio from a Duet transmitter
- HDM: High density mode
- NA HYB: Legacy digital hybrid mode
- EU HYB: Used only for certain digital hybrid transmitters marketed in the European Union
- NU HYB: Digital hybrid mode for current Lectrosonics transmitters
- JA HYB: Used only for certain digital hybrid transmitters marketed in Japan

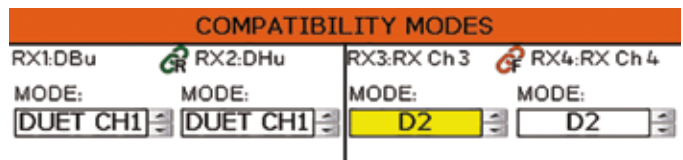

Talkback Setup

Talkback is a special function that re-directs the audio output of the transmitter in use to a different receiver output when talkback is selected on the transmitter. The normal use is to provide a “comm” channel so the person using the transmitter can have a direct line to the crew or production staff. When selected, the audio will appear at the designated talkback channel rather than the channel used for program audio.

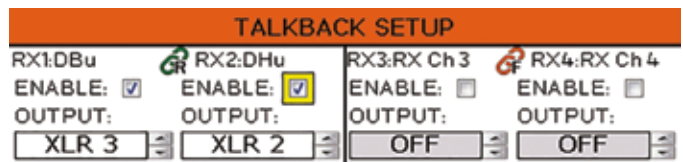

IR Sync & Encryption Menu

Encryption Key Management

The DSQD has three options for encryption keys:

- **Standard:** This is the highest level of security. The encryption keys are unique to the DSQD and there are only 256 key instances available to be transferred to a transmitter. The receiver tracks the number of keys generated and the number of times each key is transferred. Once a Standard key has been transferred 256 times, you will be alerted that a new key must be created.
- **Shared:** There are an unlimited number of shared keys available. Once generated by the DSQD and transferred to a transmitter, the encryption key is available to be shared (synced) by the transmitter with other transmitters/receivers via the IR port.
- **Universal:** This is the most convenient encryption option available. All encryption-capable Lectrosonics transmitters and receivers contain the Universal Key. The key does not have to be generated by the DSQD. Simply set a Lectrosonics encryption-capable transmitter and the DSQD to Universal, and the encryption is in place. This allows for convenient encryption amongst multiple transmitters and receivers, but not as secure as creating a unique key.

Encryption Keys

The DSQD generates high entropy encryption keys to sync with encryption-capable transmitters. The user must select a key type and create a key in the DSQD, and then sync the key with a transmitter.

1. Begin by selecting a key type.

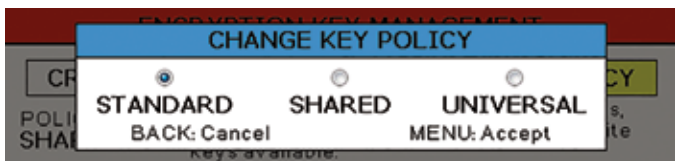

2. The DSQD will then display a warning to indicate that there is **NO KEY!** Select **CREATE KEY** to generate a new key.



NOTE: When Universal Key type is selected, there is no prompt to create key. See Encryption Key Management for more information.

3. A message will pop up on the screen warning the user that all transmitters will need a new key. Select OK. The creation of a new key is confirmed.

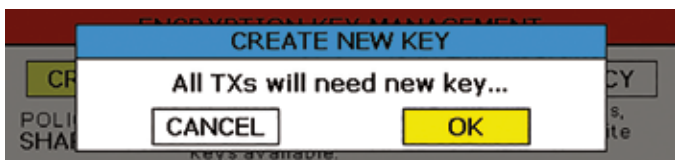

4. Sync new key with transmitter (see **Sync Key**). The transmitted audio will then be encrypted with the new key.

Sync Settings

Allows sending or retrieving setup data, including frequency, name and talkback settings, via the IR port. There are two ways to initiate a sync.

Sync options: Choose to send frequency, send all settings, retrieve (get) frequency or retrieve (get) all settings from a transmitter. Use the **UP** and **DOWN** arrows to select a function and **MENU/SEL** to initiate sync.

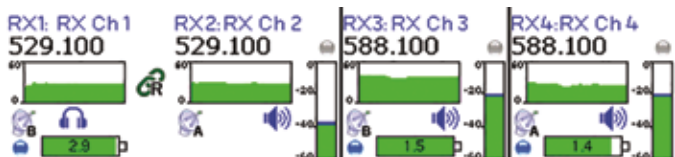

Choose Transmitter: Choose one of four Rx channels by using the **Channel Selector Buttons**, 1, 2, 3 or 4. Hold and press the Channel Selector Button to initiate sync.



NOTE: You must position the transmitter's IR port directly in front of the DSQD IR port as closely as possible, to guarantee a successful sync. A message will appear on the DSQD if the sync was successful or failed.

Sync Key

Send or retrieve (get) encryption keys.

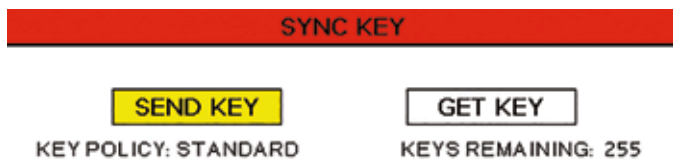

Tools and Settings Menu

RX On/Off

Use **UP** and **DOWN** arrows to toggle power on and off (to conserve power consumption).

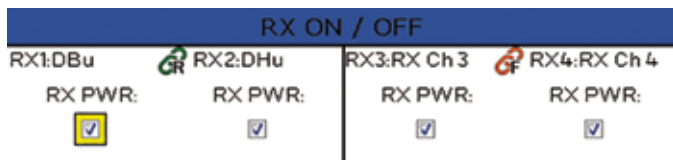

TX Battery Type

Set battery type for each channel. Use **MENU/SEL** to set and move cursor and the **UP** and **DOWN** arrows to change values.

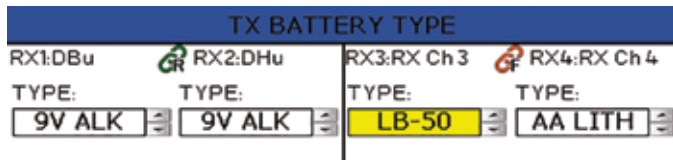

TX Battery Timer Alert

Set transmitter battery timer alerts for each channel. Choose to enable/disable alert, set time in hour and minutes and reset timer. Use **MENU/SEL** to set and move the cursor and the **UP** and **DOWN** arrows to change values.

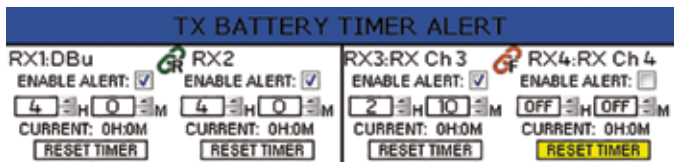

Front Panel Setup

Front panel settings may be customized as follows:

- LCD brightness: Use **UP** and **DOWN** arrows to choose from 100%, 75%, 50% or 25%
- LCD Timeout: Use **UP** and **DOWN** arrows to choose from Always On, 30 seconds, or 5 minutes
- Front Panel Lock: Use **UP** and **DOWN** arrows to turn lock on/off. When locked, menus can still be viewed, settings can not be changed. When locked, if the **UP** and **DOWN** arrows are pressed to change settings, a “FRONT PANEL LOCKED” message will appear.

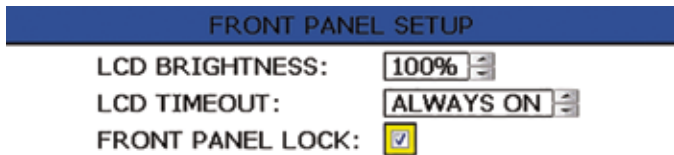

Dante Power Enable

Enable or disable Dante as needed.



Antenna Bias Power

DC bias voltage can be supplied on the antenna input BNCs from an internal source to power remote RF amplifiers.



NOTE: See Panels and Features for more information on antennas/connectors.

Network Settings

Allows the user to set network settings when needed. The following controls are available:

- DHCP Enable - this is checked if DHCP is used to assign an IP address, Netmask and Default Gateway to the device. Uncheck this to use “static” IP addressing.
- IP Address - This is in “dotted quad” format. If DHCP is enabled, this is read only.

- Netmask - This is in “dotted quad” format. If DHCP is enabled, this is read only.
- Default Gateway - This is in “dotted quad” format. If DHCP is enabled, this is read only.
- TCP Port - This is the Primary TCP port number, an integer in the range 0 - 65535. The Secondary TCP port number is not set directly - it is always the next number after the Primary TCP port number. The defaults are 4080 for the Primary port and 4081 for the Secondary port.
- MAC Address - this is the address of the device ethernet port, assigned at the factory. It is read only.

IMPORTANT: Always consult your network administrator before attempting to connect and configure a processor for a network interface.

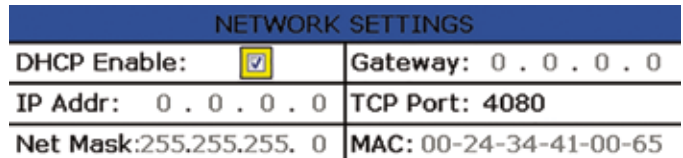

NOTE: New network settings require the unit to reboot to take effect. Making a change and pressing the **BACK** key will prompt the user to Reboot Now, Save and Exit, or Discard and Exit.

IMPORTANT: The CAT 5 Ethernet Cable must be installed prior to powering up the DSQD.

Edit Names

Edit channel names to easily identify talent or easily identify multiple DSQD receivers in a rack (1 name per frame). Use **UP** and **DOWN** Arrows to select letters and bottom buttons to set and move cursor. Press **MENU/SEL** when finished to save.



Restore Defaults

Returns all settings to the factory defaults. If YES is chosen, message will appear and DSQD will reboot.

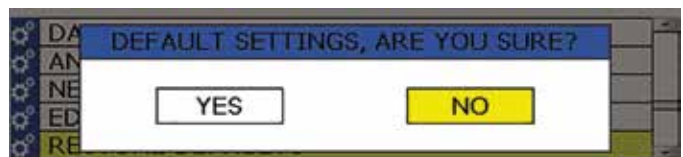

Pilot Tone Bypass

In Digital Hybrid compatibility mode ONLY, Turn Pilot Tone Bypass on/off.

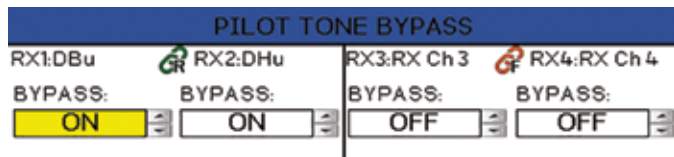

Locale



Locale optionally changes the settings on the DSQD based on the region where the receiver is being used. There are two options available:

NA: (default setting) represents the North American locale and has restricted operation over the Astronomical Band (from 608 to 614 MHz). It allows tuning from 470.100 up to 607.950 MHz.

EU: represents the European locale, and has unrestricted operation over the entire band of the device: 470.100 up to 614.375 MHz.

About

Displays general information about the DSQD, including serial number and hardware, firmware and FPGA versions.



Firmware Update Instructions

Firmware updates are made with a file downloaded from the web site and the DSQD connected via USB.

The USB port on the transmitter requires a micro-B male plug on the connecting cable. The other end of the cable would normally be a USB A-Type male connector to fit the most common type of USB jack used on computers.

Refer to **Help** in Wireless Designer software for the procedure.

Links

QR codes with links to the Lectrosonics website, the DSQD User Manual online and YouTube video tutorials.



Specifications and Features

Operating Spectrum:	470.100 - 614.375 MHz
Frequency Adjustment Range:	25 kHz steps
Sampling Size and Rate:	24-bit, 48 kHz
Digital Modulation:	8PSK with Forward Error Correction
Data Encoding:	Proprietary ADPCM
Encryption:	AES 256-CTR (per FIPS 197 and FIPS 140-2)
System Latency:	
Digital Output:	D2 mode: 1.4 ms plus Dante Duet mode: 1.4 ms plus Dante Hybrid modes: 2.0 ms plus Dante
Analog Output:	D2 mode: 1.9 ms Duet mode: 1.9 ms Hybrid modes: 2.5 ms
Audio Performance:	
Frequency Response:	20 Hz - 20 KHz, +/-1 dB
THD+N:	0.05% (1 KHz @ -10 dBFS)
Dynamic Range:	108 dB A-wtd, NR=NORMAL
Adjacent Channel Isolation:	>85 dB
Diversity Technique:	Noiseless antenna switching
Sensitivity:	-98 dBm for 10 ⁻⁵ BER
Antenna Inputs/Outputs:	Dual BNC female, 50 ohm impedance
Audio Outputs:	
XLR:	Balanced, -35 to +8 dBu
Headphone:	1/8 inch phone jack
Dante:	RJ45 Gigabit Ethernet
AES3:	TA3M
External DC Power:	7 to 18 VDC; 2.5A (max)
Weight:	2.04 lbs.; 926 grams
Dimensions:	8.375 x 1.75 x 7.375 in. 213 x 44.5 x 187 mm.

Specifications subject to change without notice.

Wireless Designer

Download the Wireless Designer software installer from the website under the SUPPORT tab at:

<https://lectrosonics.com/support.html>

Wireless Designer only needs to be installed the first time the software is used. Once the software is installed, updates are available by simply clicking on an item in the Help Menu.

NOTE: If Wireless Designer is already installed, you must uninstall it before attempting to install a new copy.

Supplied Hardware

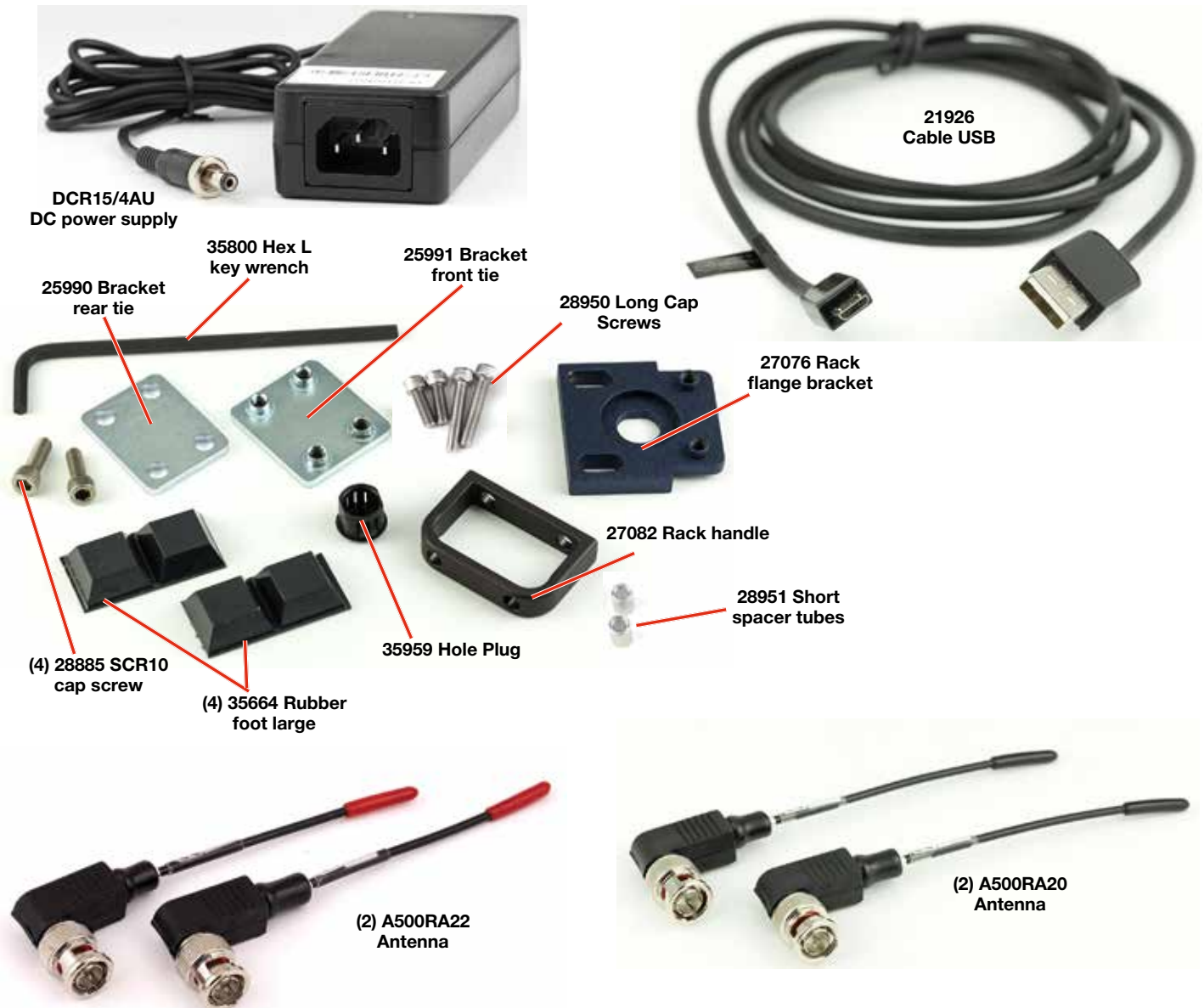

Unpacking the Unit

Compare the packing list enclosed with the DSQD with the original order. Inspect all items for damage. Immediately call 1-800-821-1121 to report any items that are missing or damaged. The sooner we get notified, the sooner we can get any needed replacement items shipped to your location.

NOTE: Each DSQD includes hardware to mount two (2) DSQD receivers in a rack.

Items Included in the Box:

- Instruction manual
- (DCR15/4AU) Power supply cable
- (21926) USB cable
- (35800) Hex L key wrench
- (25990) Bracket rear tie
- (25991) Bracket front tie
- (27076) Rack flange bracket
- (27082) Rack handle
- (28885) (4) SCR10 cap screw
- (28951) (2) Short spacer tubes
- (28950) (2) Long cap screw
- (35664) (4) Rubber foot large
- (35959) Hole plug
- (A500RA20) (2) Antenna
- (A500RA22) (2) Antenna

Optional Accessories

27080 Dante Port Cover



SNA600a Antenna

Adjustable elements tune center frequency from 550 to 800 MHz; 3/8" x 16 threaded socket and stud with mounting strap included



Front Mount Antenna Kit FMAKM2T



ALP690 Antenna

Broad bandwidth for multi-channel systems; directional pattern with 4 dBd RF gain; built-in RF amplifier; versatile mounting options



Coaxial Antenna Cable:

ARG 15

A 15 foot antenna cable of standard RG-58 coax cable with BNC connectors at each end.



ARG 25; ARG 50; ARG 100

Antenna cable of Belden 9913F low-loss coax cable with BNC connectors at each end. Number specifies length in feet.



RMPM2T-1

Kit for mounting one DSQD into a single rack space.



Installing two DSQD Receivers into a Single Rack Space

The DSQD receiver occupies a half rack space, and comes with hardware to mount two receivers into a single rack space.

1. Remove the Trim Cap (Part #P1330) from both sides of the front panel on both receivers.



2. Remove the breakaway tabs on both sides of the chassis side panels. Use a flat blade screwdriver to pry the tabs outward and snap them off of the chassis.

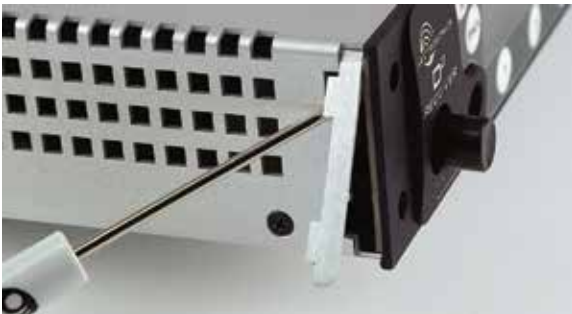

3. Insert the flange bracket (Part #27076) into the open slot in the side of the chassis cover panel.



4. Insert two (2) cap screws (Part #28885) through the rack handle (Part #27082) holes and install the rack handle onto the flange bracket through the holes in the unit's front panel. Firmly tighten the cap screws using the hex key (Allen wrench) as shown.



5. If antennas will NOT be mounted on the front panel of the receivers, install the hole cap (Part #35959) by aligning the flat on the cap with the flat on the opening.



NOTE: The retaining nuts on the panel and tie brackets are “tensioning lock nut” types designed to prevent the screws from coming loose due to vibration. You will usually feel resistance as you tighten the screws - this is normal.



6. Install one side of the front tie bracket (Part #25991) into the side panel opening in one of the receivers. Insert the screws, but do not tighten them completely at this point.

Slide the other receiver over the tie bracket and insert the screws, but do not tighten them completely until the rear tie bracket is installed.



7. Remove the four cap screws from the adjacent rear panels, and then use them to attach the rear tie bracket. Do not tighten the screws completely.



8. After front and rear tie brackets are installed, place the receivers on a flat surface so that the front panels are even with each other. Hold the receivers in place and tighten all cap screws on the front and rear brackets.

NOTE: If the supplied rubber feet are installed on under side of DSQD, it will not fit in a rack unless there is an empty space below it.

M2T/DSQD Rack Mounting Instructions

The M2T transmitter occupies a half rack space. This kit provides the hardware needed to mount one M2T or DSQD into a single rack space.

NOTE: Steps 1-6 will require original mounting hardware that came with the units. Part numbers are included in case individual items need to be reordered.

1. Remove the Trim Cap (Part #P1330) from both sides of the front panel of the M2T unit to be rack mounted.



2. Remove the breakaway tabs on both sides of the Chassis Cover Panel. This requires the use of a flat-blade screwdriver inserted into the slots and levering the tabs away on each side of the unit.



3. Insert the Flange Bracket (Part #27076) into the open slot in the left-front side of the Chassis Cover Panel.



4. Insert two (2) Cap Screws (Part #28885) through the Rack Handle (Part #27082) holes and install the Rack Handle onto the Flange Bracket through the holes in the unit's front panel. Firmly tighten the Cap Screws using the long leg of the Hex Wrench as shown.



5. Unless also installing a Front Mounted Antenna, insert the Hole Plug (Part #35959) into the open antenna hole in the Flange Bracket by aligning the flat sides of the plug with those of the bracket hole and pushing into place until flush.



6. Install the Front Tie Bracket (Part #25991) into the open slot in the right side of the M2T Chassis Cover Panel with the protruding nuts facing rearward, affix with two (2) Cap Screws (Part #28885) provided and firmly tighten with the Hex Wrench. See next page.

NOTE: Steps 7-11 require parts from the (RMPM2T-1) M2T Single Rack Mount Kit.

M2T Front View

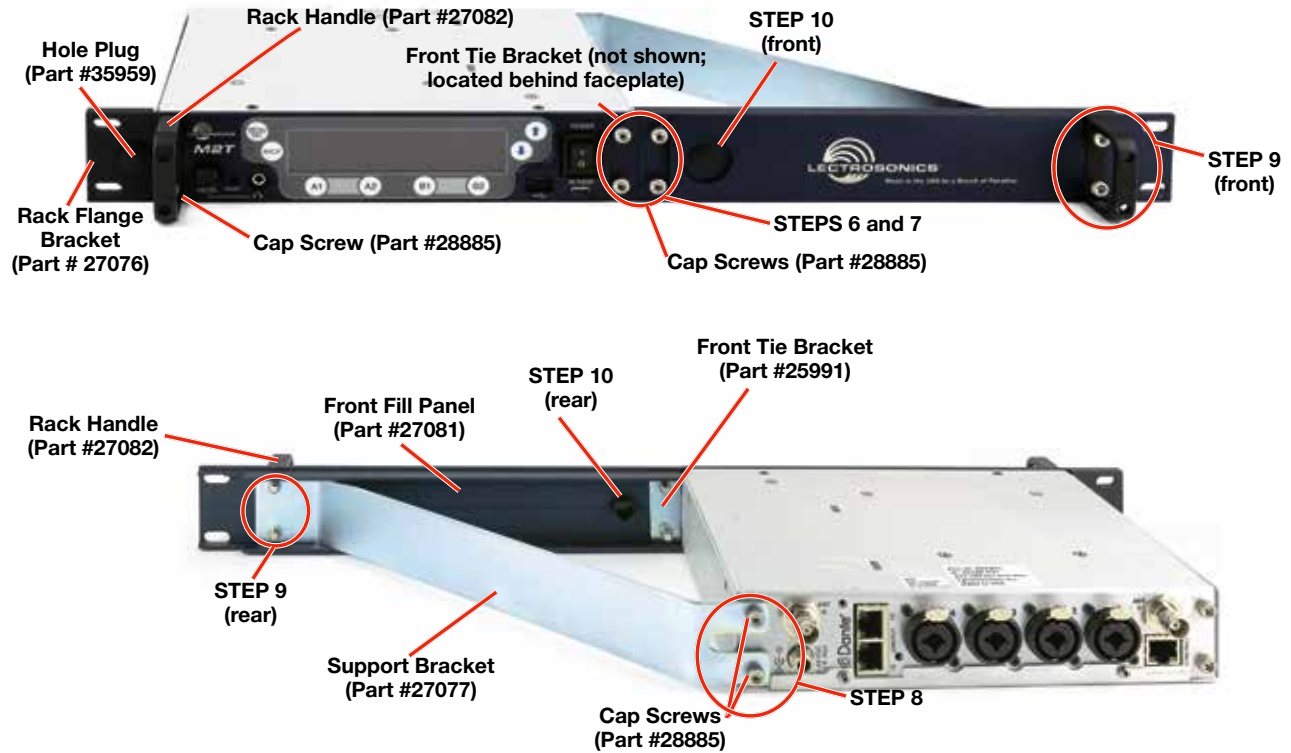

Items Included in RMPM2T-1 Kit:

- Technical Data Sheet
- (27077) Support Bracket
- (27081) Front Fill Panel
- (27082) Rack handle
- (28885) (4) SCR10 cap screw
- (35800) Hex L key wrench
- (35959) Hole plug
- (28950) (2) Long mounting screws*
- (28951) (2) Short spacer tubes*

NOTE: Starred (*) items are needed only when installing a DSQD, They are not needed for M2T installation and may be set aside.



7. Use two (2) Cap Screws (Part #28885) to attach the left side of the Front Fill Panel (Part #27081) to the two remaining nuts on the Front Tie Bracket (Part #25991) and firmly tighten with the Hex Wrench.
8. Use the Hex Wrench to remove the two (2) in-board Cap Screws from the rear of the M2T. Install the Support Bracket (Part #27077) to the rear panel of the M2T, reusing the two (2) Cap Screws previously removed and firmly tighten with the Hex Wrench. (See rear view image above.)
9. Insert two (2) Cap Screws (Part #28885) through Rack Handle (Part #27082) holes and install the Rack Handle onto the right side Front Fill Panel (Part #27081) through the holes in the panel,

and into the nuts on the Support Bracket (Part #27076). Firmly tighten the Cap Screws using the long leg of the Hex Wrench. (See rear and front view images on front page.)

10. Unless also installing a Front Mounted Antenna, insert the Hole Plug (Part #35959) into the open antenna hole in the Front Fill Panel (Part #27081) by aligning the flat sides of the plug with those of the bracket hole and pushing into place until flush.

The M2T with Front Fill Panel is now ready for installation into a rack.

NOTE: If supplied rubber foot/feet are installed on under side of the M2T, it will not fit in a single rack space.

DSQD Rear View

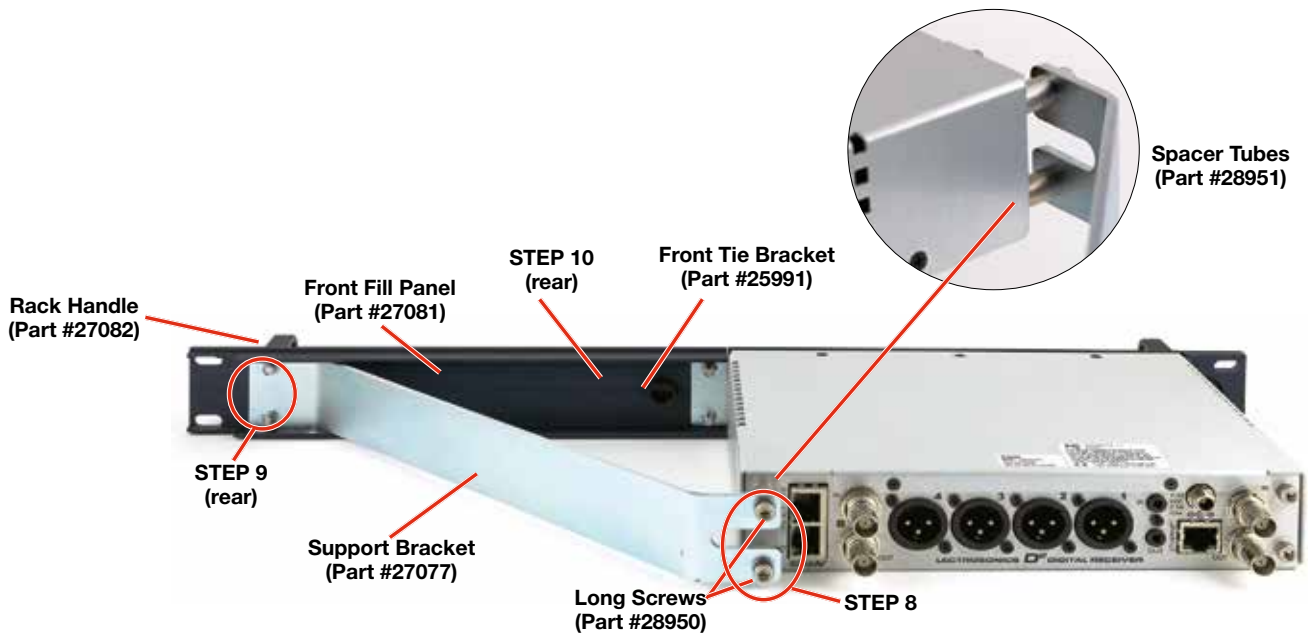

Installing One DSQD into a Single Rack

The process to install the DSQD is the same as for the M2T transmitter through Step 7. The DSQD looks similar to the M2T in the frontal view. Follow the steps for the M2T, then resume at Step 8:

8. Use the Hex Wrench to remove the two (2) in-board Cap Screws from the rear of the DSQD. Put them aside and save for later use or spares; you will not need them for this installation. Install the Support Bracket (Part #27077) to the rear panel of the DSQD, using the two (2) long mounting screws, threaded with Spacer Tubes, and firmly tighten with the Hex Wrench. See rear view image and call-out photo above. The kit is designed to handle the M2T and the DSQD with a shorter chassis, so the spacers are included.
9. Insert two (2) Cap Screws (Part #28885) through the Rack Handle (Part #27082) holes and install the Rack Handle onto the right side Front Fill Panel (Part #27081) through the holes in the panel, and into the nuts on the Support Bracket (Part #27076). Firmly tighten the Cap Screws using the long leg of the Hex Wrench.
10. Unless also installing a Front Mounted Antenna, insert the Hole Plug (Part #35959) into the open antenna hole in the Front Fill Panel (Part #27081) by aligning the flat sides of the plug with those of the bracket hole and pushing into place until flush.

The DSQD with Front Fill Panel is now ready for installation into a rack.

NOTE: As with the M2T, if the supplied rubber foot/feet are installed on under side of the DSQD, it will not fit in a single rack space.

Mounting M2T To DSQD

When mounting two M2Ts or two DSQDs together, the units lie flush together as shown. This is not the case with an M2T and a DSQD, as the DSQD housing is shorter and the spacer tubes are needed.



Two M2T units



Two DSQD units

When attaching an M2T to a DSQD unit, the preferred configuration (when viewing from the back side) is to have the DSQD to the left and the M2T to the right. If the units are mounted the opposite way, the mounting plate will partially block the Dante® ports on the DSQD, making it difficult to remove the cables. Having the DSQD on the left as shown below eliminates this inconvenience.



Recommended DSQD-M2T mounting

Troubleshooting

RF Meter Not Showing Green

RF Level status colors and their meanings are explained on Page 8.

No Power/Intermittent Power

If you have checked your power supply and all of your external connections, you may have a blown fuse. Disconnect your DSQD from its power source, remove the top cover and inspect the pink front fuse. **You will not void the warranty by doing so:**

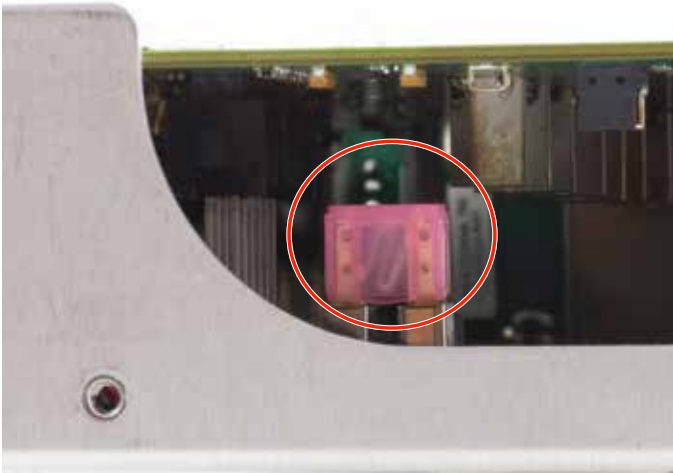

This is a standard 4A, 32VDC mini blade (automotive type) fuse. You can obtain one from any automotive or electrical supply shop, or order one from us (part #21941). Replace if necessary.

Service and Repair

If your system malfunctions, you should attempt to correct or isolate the trouble before concluding that the equipment needs repair. Make sure you have followed the setup procedure and operating instructions. Check the interconnecting cables and then go through the **Troubleshooting** section in this manual.

We strongly recommend that you **do not** try to repair the equipment yourself and **do not** have the local repair shop attempt anything other than the simplest repair. If the repair is more complicated than a broken wire or loose connection, send the unit to the factory for repair and service. Don't attempt to adjust any controls inside the units. Once set at the factory, the various controls and trimmers do not drift with age or vibration and never require readjustment. **There are no adjustments inside that will make a malfunctioning unit start working.**

LECTROSONICS' Service Department is equipped and staffed to quickly repair your equipment. In warranty repairs are made at no charge in accordance with the terms of the warranty. Out-of-warranty repairs are charged at a modest flat rate plus parts and shipping. Since it takes almost as much time and effort to determine what is wrong as it does to make the repair, there is a charge for an exact quotation. We will be happy to quote approximate charges by phone for out-of-warranty repairs.

Returning Units for Repair

For timely service, please follow the steps below:

- A.** DO NOT return equipment to the factory for repair without first contacting us by email or by phone. We need to know the nature of the problem, the model number and the serial number of the equipment. We also need a phone number where you can be reached 8 A.M. to 4 P.M. (U.S. Mountain Standard Time).
- B.** After receiving your request, we will issue you a return authorization number (R.A.). This number will help speed your repair through our receiving and repair departments. The return authorization number must be clearly shown on the **outside** of the shipping container.
- C.** Pack the equipment carefully and ship to us, shipping costs prepaid. If necessary, we can provide you with the proper packing materials. UPS is usually the best way to ship the units. Heavy units should be "double-boxed" for safe transport.
- D.** We also strongly recommend that you insure the equipment, since we cannot be responsible for loss of or damage to equipment that you ship. Of course, we insure the equipment when we ship it back to you.

Lectrosonics USA:

Mailing address:

Lectrosonics, Inc.
PO Box 15900
Rio Rancho, NM 87174
USA

Shipping address:

Lectrosonics, Inc.
561 Laser Rd. NE, Suite 102
Rio Rancho, NM 87124
USA

Telephone:

(505) 892-4501
(800) 821-1121 Toll-free
(505) 892-6243 Fax

Web:

www.lectrosonics.com

E-mail:

sales@lectrosonics.com
service.repair@lectrosonics.com

Lectrosonics Canada:

Mailing Address:

720 Spadina Avenue,
Suite 600
Toronto, Ontario M5S 2T9

Telephone:

(416) 596-2202
(877) 753-2876 Toll-free
(877-7LECTRO)
(416) 596-6648 Fax

E-mail:

Sales: colinb@lectrosonics.com
Service: joe@lectrosonics.com

Self-Help Options for Non-Urgent Concerns

Our Facebook groups and weblists are a wealth of knowledge for user questions and information. Refer to:

Lectrosonics General Facebook Group: <https://www.facebook.com/groups/69511015699>

D Squared, Venue 2 and Wireless Designer Group: <https://www.facebook.com/groups/104052953321109>

The Wire Lists: <https://lectrosonics.com/the-wire-lists.html>

FCC Notice

NOTE: This equipment has been tested and found to comply with the limits for a Class B digital device, pursuant to part 15 of the FCC Rules. These limits are designed to provide reasonable protection against harmful interference in a residential installation. This equipment generates, uses and can radiate radio frequency energy and, if not installed and used in accordance with the instructions, may cause harmful interference to radio communications. However, there is no guarantee that interference will not occur in a particular installation. If this equipment does cause harmful interference to radio or television reception, which can be determined by turning the equipment off and on, the user is encouraged to try to correct the interference by one or more of the following measures:

- Reorient or relocate the receiving antenna.
- Increase the separation between the equipment and receiver.
- Connect the equipment into an outlet on a circuit different from that to which the receiver is connected.
- Consult the dealer or an experienced radio/TV technician for help.

Changes or modifications to this equipment not expressly approved by Lectrosonics, Inc. could void the user's authority to operate it.

ISED Notices:

Per RSS-210

This device operates on a no-protection no-interference basis. Should the user seek to obtain protection from other radio services operating in the same TV bands, a radio licence is required. Please consult Industry Canada's document CPC-2-1-28, Optional Licensing for Low-Power Radio Apparatus in the TV Bands, for details.

Ce dispositif fonctionne selon un régime de non-brouillage et de non-protection. Si l'utilisateur devait chercher à obtenir une certaine protection contre d'autres services radio fonctionnant dans les mêmes bandes de télévision, une licence radio serait requise. Pour en savoir plus, veuillez consulter le document CPC-2-1-28 d'Industrie Canada intitulé, Délivrance de licences sur une base volontaire pour les appareils radio de faible puissance exempts de licence et exploités dans les bandes de télévision.

Per RSS-Gen

This device complies with Industry Canada's license-exempt RSSs. Operation is subject to the following two conditions:

- 1) This device may not cause interference*
- 2) This device must accept any interference, including interference that may cause undesired operation of the device.*

Le présent appareil est conforme aux CNR d'Industrie Canada applicables aux appareils radio ex-empts de licence. L'exploitation est autorisée aux deux conditions suivantes :

- 1) l'appareil ne doit pas produire de brouillage;*
- 2) l'appareil doit accepter tout brouillage radioélectrique subi, même si le brouillage est sus-*



P.O. Box 15900 - Rio Rancho, NM - 87174 - USA
 Phone: (800)821-1121 or (505)892-4501 - Fax: (505)892-6243
 web: www.lectrosonics.com - email: sales@lectrosonics.com

EU Declaration of Conformity

LECTROSONICS, INC.
581 Laser Road
Rio Rancho, NM 87124 USA

Declares under our sole responsibility that the following product:

Model: DSQD

Wireless microphone receiver

is in conformity with the provisions of the following EC directive(s) (including applicable amendments) and are designed and manufactured in accordance with the harmonized standards:

Document	Description	Date/Version
RL 2014/53/EU	Radio Equipment Directive 2014/53/EU (RED)	2014-04
EN 300 422-1	Wireless Microphones; Audio PMSE up to 3 GHz; Part 1: Class A Receivers	V2.1.2 (2017-01)
	Electromagnetic Compatibility	
EN 301 489-1	ElectroMagnetic Compatibility (EMC) standard for radio equipment and services; Common Technical Requirements	V2.1.1 (2016-11)
EN 301 489-9	Specific Conditions for wireless microphones, similar Radio Frequency (RF) audio link equipment, cordless audio and in-ear monitoring devices	V2.1.0 (2016-09)
	Safety and Health	
EN 60065-1	Audio, video and similar electronic apparatus – Safety Requirements	2006+A11:2009+A1:2010+A12:2011+A2:2013
RL 2011/65/EU	RoHS Directive 2011/65/EU; Restriction of the use of certain hazardous substances (RoHS Recast)	2011

The EU type examination was performed by notified body Siemic, Inc.

Software version of DSQD: 0.2.07

Rio Rancho, NM USA, 10 Sep 2018

Robert Cummings
 V.P. Engineering
 Lectrosonics, Inc.

LIMITED ONE YEAR WARRANTY

The equipment is warranted for one year from date of purchase against defects in materials or workmanship provided it was purchased from an authorized dealer. This warranty does not cover equipment which has been abused or damaged by careless handling or shipping. This warranty does not apply to used or demonstrator equipment.

Should any defect develop, Lectrosonics, Inc. will, at our option, repair or replace any defective parts without charge for either parts or labor. If Lectrosonics, Inc. cannot correct the defect in your equipment, it will be replaced at no charge with a similar new item. Lectrosonics, Inc. will pay for the cost of returning your equipment to you.

This warranty applies only to items returned to Lectrosonics, Inc. or an authorized dealer, shipping costs prepaid, within one year from the date of purchase.

This Limited Warranty is governed by the laws of the State of New Mexico. It states the entire liability of Lectrosonics Inc. and the entire remedy of the purchaser for any breach of warranty as outlined above. NEITHER LECTROSONICS, INC. NOR ANYONE INVOLVED IN THE PRODUCTION OR DELIVERY OF THE EQUIPMENT SHALL BE LIABLE FOR ANY INDIRECT, SPECIAL, PUNITIVE, CONSEQUENTIAL, OR INCIDENTAL DAMAGES ARISING OUT OF THE USE OR INABILITY TO USE THIS EQUIPMENT EVEN IF LECTROSONICS, INC. HAS BEEN ADVISED OF THE POSSIBILITY OF SUCH DAMAGES. IN NO EVENT SHALL THE LIABILITY OF LECTROSONICS, INC. EXCEED THE PURCHASE PRICE OF ANY DEFECTIVE EQUIPMENT.

This warranty gives you specific legal rights. You may have additional legal rights which vary from state to state.

